

MCA 枠

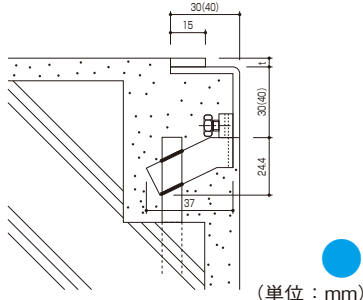

(単位: mm)

蓋厚み (t)	4 t 用	アングルサイズ	L3 × 30 × 30
	5 t 用		L3 × 40 × 40

MCA-Q 枠 (クッションゴム付)

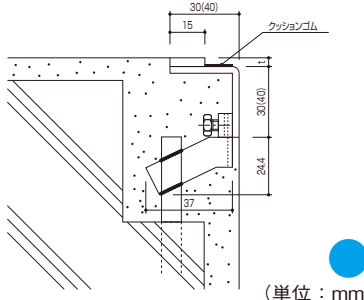
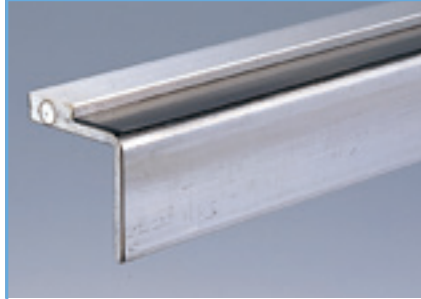

(単位: mm)

蓋厚み (t)	4 t 用	アングルサイズ	L3 × 30 × 30
	5 t 用		L3 × 40 × 40

H-Q 枠 (クッションゴム枠)

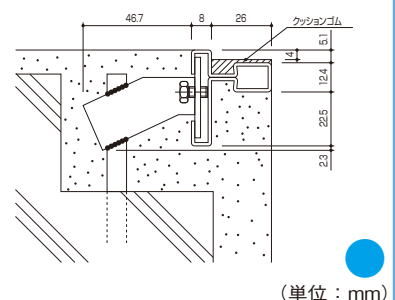

(単位: mm)

蓋厚み (t)	3 t 用
	4 t 用

APF- II -C 枠 (クッションゴム枠)

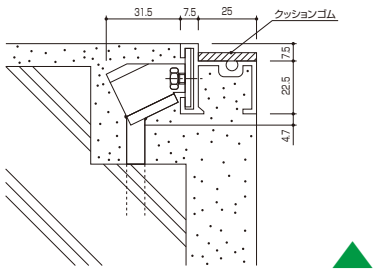
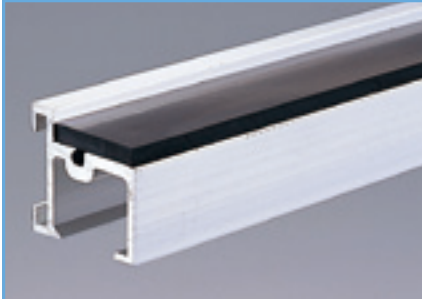

(単位: mm)

蓋厚み (t)	3 t 用
	4 t 用
	5 t 用

MBN 枠

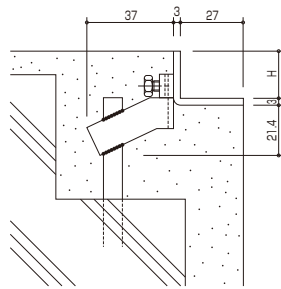
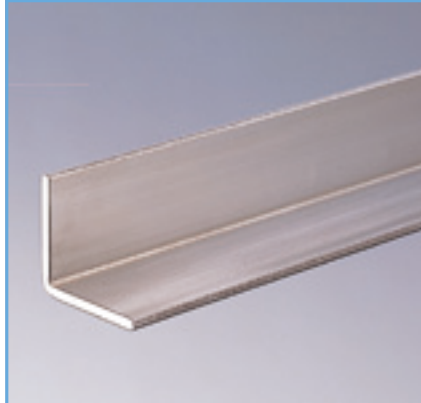

(単位: mm)

MBN-Q 枠

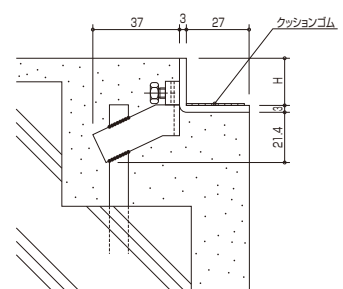
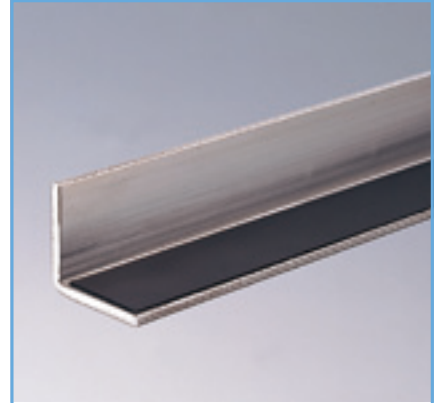

(単位: mm)